

- Placement of clamps and roof bars
- Placement des pattes fixation et d barres de toit
- Platzierung der Klemmen und bars
- Colocación de las grapas de fijación en las barras de techo

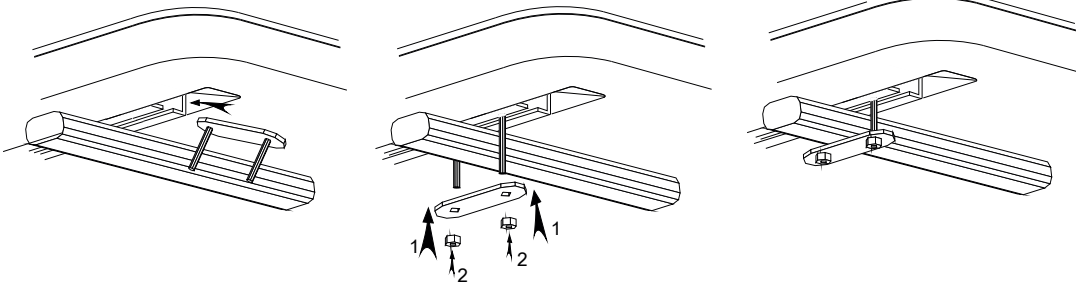

- Position and distribution of the roof racks
- Positionnement et la distribution des barres de toit
- Positionierung und den Vertrieb von Dachtrager
- Posición y distribución de las barras de techo

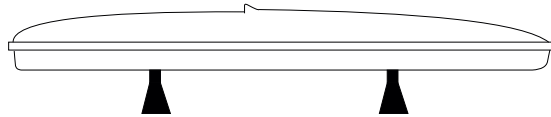

- With 2 Bars
- Avec 2 barres
- Mit 2 Bars
- Con 2 barras

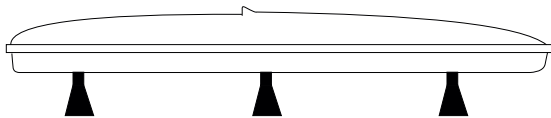

- With 3 Bars
- Avec 3 barres
- Mit 3 Bars
- Con 3 barras

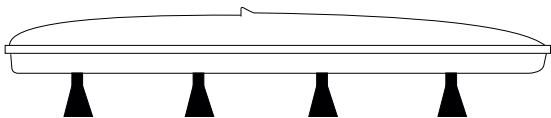

- With 4 Bars
- Avec 4 barres
- Mit 4 Bars
- Con 4 barras

(Minimum weight supported by bar should be 45kg / Poids minimum supporté par barre devrait être 45kg / Mindestgewicht von 45kg unterstützt wird, sollte sein.)
(Peso mínimo soportado por barra deberá ser 45 Kg)



ATTENTION!!

- EN/** Mattress placement instructions **FR/** Instructions de placement de matelas
- DE/** Matratze Platzierungsanweisungen **ES/** Instrucciones de colocación del colchón:

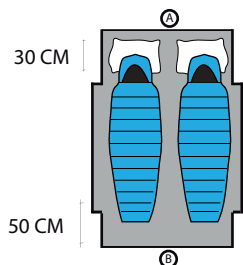

- EN/** After maintenance place the mattress on his original position
- FR/** Après l'entretien, placez le matelas sur sa position d'origine
- DE/** Nach der Instandhaltung die matratze auf die ursprüngliche position bringen
- ES/** Después del mantenimiento coloque el colchón en su posición original

(A)

- EN/** Tent front
- FR/** Avant de la tente
- DE/** Zelt vorne
- ES/** Frente de la tienda

(B)

- EN/** Tent rear
- FR/** Arrière de la tente
- DE/** Zelt hinten
- ES/** Trasera de la tienda



- EN/** User Guide
- FR/** Guide de L'utilisateur
- DE/** Benutzerhandbuch
- ES/** Guía del usuario

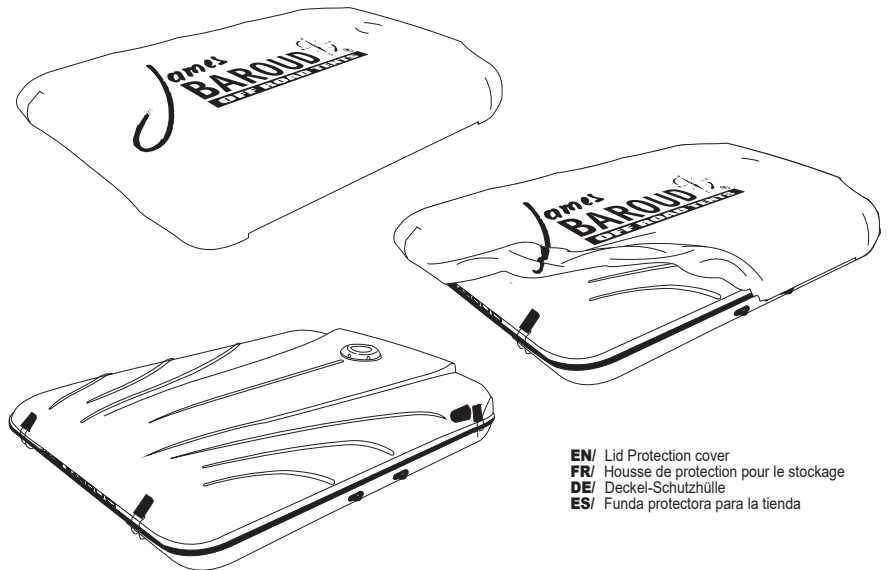

- EN/** Lid Protection cover
- FR/** Housse de protection pour le stockage
- DE/** Deckel-Schutzhülle
- ES/** Funda protectora para la tienda

Discovery / Discovery XXL / Extreme / Extreme XXL

OPEN

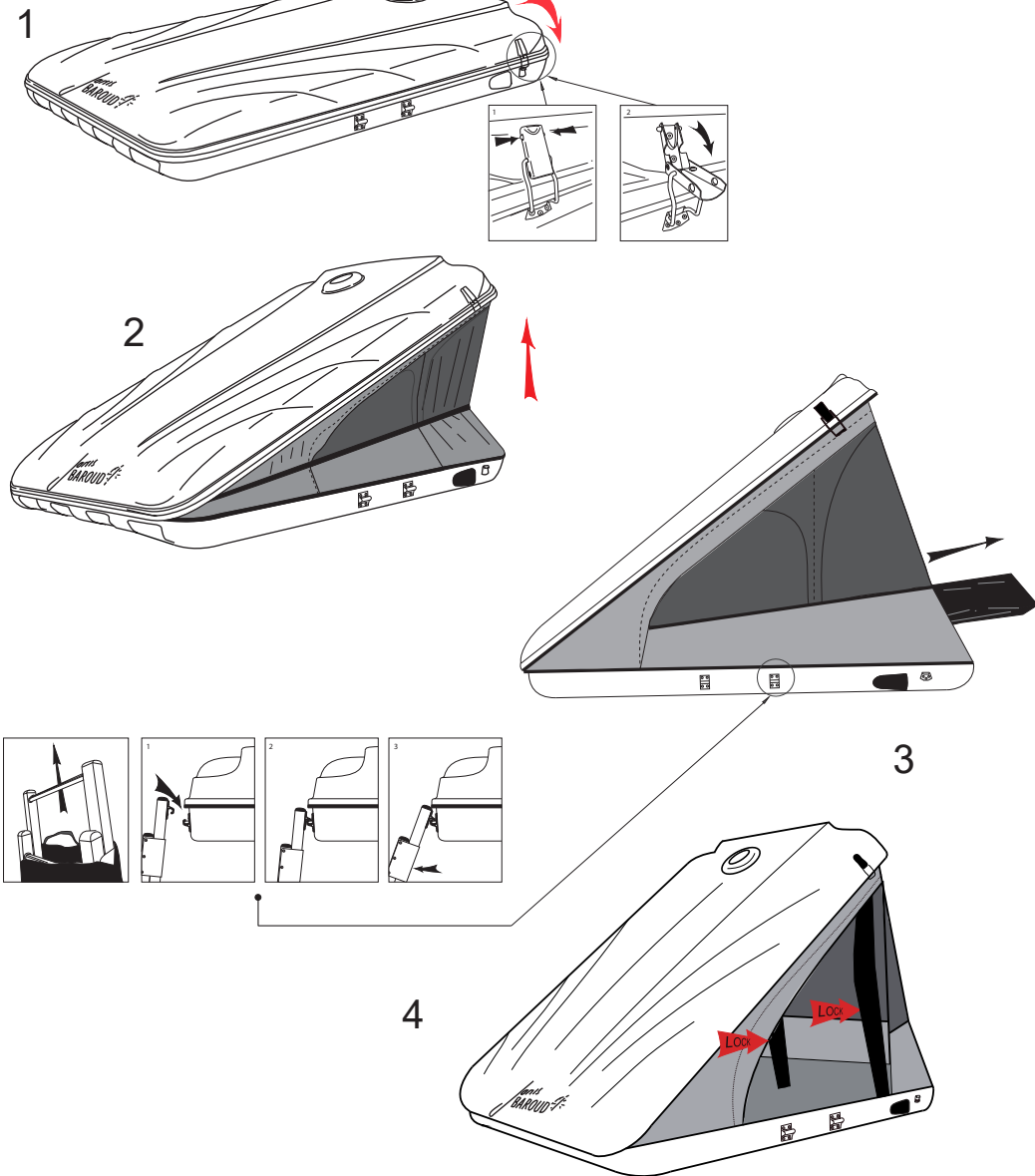

OPENING INSTRUCTIONS / INSTRUCTIONS D'OUVERTURE/ ERÖFFNUNGSVERFAHREN/ INSTRUCCIONES DE APERTURA

- | | | | |
|---|---|---|--|
| <p>1 EN Open rear latches
 FR Ouvrir les fermetures arrière
 DE Öffne hintere Riegel
 ES Abrir los cierres traseros</p> | <p>2 EN Open the tent rear
 FR Ouvrir l'arrière de la tente
 DE Öffnen Sie das Zelt Hinter
 ES Abrir la parte trasera de tienda</p> | <p>3 EN Remove and place the ladder
 FR Retirer et placez l'échelle
 DE Setzen Die Leiter
 ES Retirar la escalera y colocar</p> | <p>4 EN Lock the tent arms
 FR Bloquer les bras de la tente
 DE Sperren Sie die Arme
 ES Bloquear los brazos</p> |
|---|---|---|--|



CLOSE

IMPORTANT!
 Before closing the tent please turn off the solar fan.
 Not turning off may cause overheating.

IMPORTANT!
 Avant de fermer la tente, veuillez arrêter le ventilateur solaire.
 Ne pas l'arrêter peut provoquer une surchauffe.

WICHTIG!
 Bevor Sie das Zelt schließen, schalten Sie bitte den Solarlüfter aus.
 Nicht abschalten kann Überhitzung verursachen.

¡IMPORTANTE!
 Antes de cerrar la tienda, apague el ventilador solar. No apagarlo puede causar sobrecalentamiento.

2

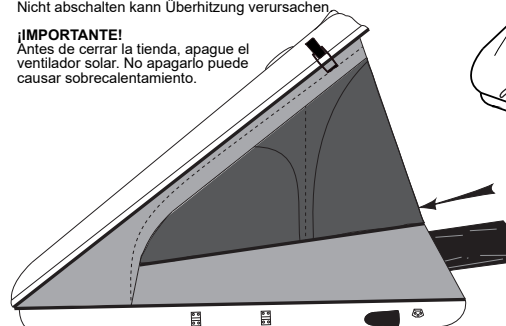

CAUTION!
 When closing the tent place all cursors along the red marks.

ATTENTION!
 Lors de la fermeture de la tente, amener les curseurs au niveau des marques rouges.

WAARSCHUWING!
 Während des Schließens des Zeltes, stellen Sie cursor auf die roten Markierungen.

¡ATENCIÓN!
 Al cerrar la tienda poner todos los cursors al largo de las marcas rojas.

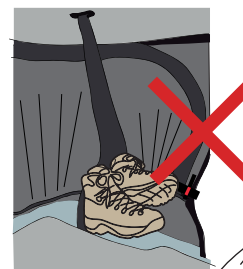
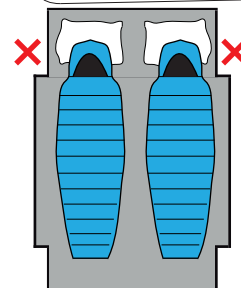
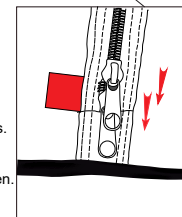

IMPORTANT!
 When closing the tent do not place any object under the arms of the mechanisms.

IMPORTANT!
 Avant de fermer la tente, ne placez aucun objet sous les bras des mécanismes.

WICHTIG!
 Stellen Sie beim Schließen des Zeltes keine Gegenstände unter die Arme der Mechanismen.

¡IMPORTANTE!
 Antes de cerrar la tienda, no coloque ningún objeto debajo de los brazos de los mecanismos.

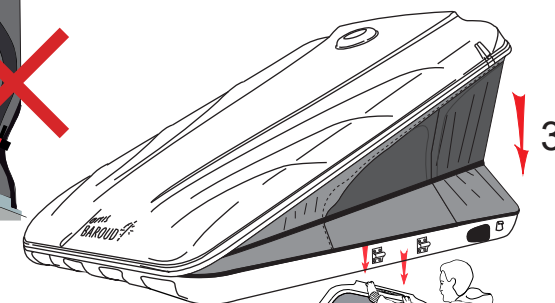

3



CAUTION!
 When closing the tent do not leave fabric out.

WAARSCHUWING!
 Wenn Sie das Zelt schließen, lassen Sie den Stoff nicht draußen.

ATTENTION!
 Lors de la fermeture de la tente, ne laissez pas la toile à l'extérieur.

¡ATENCIÓN!
 Al cerrar la tienda, no deje la tela afuera.



IMPORTANT!
 Do not press the front or rear of the tent to close the tent at the risk of losing the warranty. Hairlines cracks in the gel coat may occur due to misuse of the product.

IMPORTANT!
 Ne pas pousser dessus la tente pour fermer au risque de perdre la garantie. Une mauvaise utilisation du produit peut provoquer des micro-fissures dans le gel-coat.

WICHTIG!
 Drücken Sie nicht auf die Vorder- oder Rückseite des Zeltes, um das Zelt zu schließen, um die Garantie zu verlieren. Risse im Gelcoat können durch Missbrauch des Produkts auftreten.

¡IMPORTANTE!
 No presione la parte frontal o trasera de la tienda al cerrar sob el riesgo de perder la garantía. La mala utilización del producto pueden provocar micro-fisuras en el gel-coat.

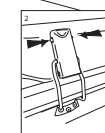
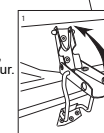

4

CLOSING INSTRUCTIONS / INSTRUCTIONS DE FERMETURE/ SCHLIEBENSVERFAHREN/ INSTRUCCIONES DE CIERRE

- | | | | |
|---|---|---|---|
| <p>1 EN Unlock the tent arms
 FR Débloquer les bras de la tente
 DE Lösen Sie die Arme
 ES Desbloquear los brazos</p> | <p>2 EN Stow the ladder / Important: Close the tent using the side straps
 FR Ranger l'échelle / Important: pour fermer la tente utiliser la poignée sur le côté
 DE Vereinbaren die Leiter / Schließen Sie die Zeltfront mit den Vorderseitengurten
 ES Guardar la escalera/ Importante: Cierre la tienda utilizando las correas laterales</p> | <p>3 EN Close the tent rear
 FR Fermer l'arrière de la tente
 DE Schließen Sie das Zelt Hinter
 ES Cerrar la parte trasera de la tienda</p> | <p>4 EN Close rear latches
 FR Fermer les fermetures arrière
 DE Schließen hintere Riegel
 ES Cerrar los cierres traseros</p> |
|---|---|---|---|